

The Keyless Mechanism

A Practical Treatise on its Design and Repair

By

B. Hillmann

3rd Edition

Translated by

Ch. Gros

PARIS

Office of the Almanac de l'Horlogerie-Bijouterie

1, Rue Borda

Librairie Centrale des Sciences

27, Quai des Grands-Augustins

English translation by

Richard Watkins

Kingston, Tasmania

© Copyright, 2004, Richard Watkins

Other translations by Richard Watkins:

Anon (G.A. Berner?): *Some notes on Pierre-Frederic Ingold and the work of E. Haudenschild.*

Jacques David: *American and swiss watchmaking in 1876, reports to the International Committee of Jura Industries on the manufacture of watches in the United States.*

Eduard Favre-Perret: *Philadelphia Exhibition 1876, report presented to the Federal High Council on the Horology Industry.*

Emile Graupmann: *The finishing of the watch case.*

Moritz Grossmann: *Prize essay on the construction of a simple and mechanically perfect watch.*

Jerome Lalande: *Jerome Lalande, diary of a trip to England 1763.*

All except the reports by Jacques David can be downloaded from www.watkinsr.id.au.

Translator's Preface

Between 1900 and 1925 Bruno Hillmann wrote four books on watch repair; these are *Der zylindergang, konstruktion und reparatur der zylinderuhren*, 1904; *Der kronenaufzug, konstruktion und reparatur*, 1910; *Die reparatur des komplizierter taschenuhren*, 1911; and *Die armbanduhr ihr wesen und ihre behandlung bei der reparatur*, 1925.

All were translated into French, but the only one translated into English was *The repair of complicated watches*, which is the main part of *Complicated watches* published by Seibel and Hagans in 1945.

Curiosity (and the desire to put off another, much more difficult translation!) led me to produce this English version of his book on keyless mechanisms.

Besides being an excellent description of, and repair guide for keyless mechanisms, Hillmann's writing is laced with invective against poor watches and stupid designs, and it is a delight to read; even if, like me, you rarely overhaul watches.

Finally, being nearly 100 years old, I believe the original book is no longer covered by copyright. I feel uneasy about publishing a translation without permission and I have attempted to locate the person or organisation that may have owned the copyright, but without success. As this is a not-for-profit publication, produced so that English speaking people can benefit from Hillmann's writing, I hope no-one will be offended. Indeed, I suspect Hillmann would be pleased that his work is at last available to English speaking people, even though it is about 80 years too late.

Richard Watkins
Kingston, Tasmania, 2004
www.watkinsr.id.au

Contents

Introduction	5
I Gears.	6
Gearing of the winding pinion with the crown wheel.	6
Gearing of the winding pinion with the castle wheel.	9
Gearing of the transmission wheel with the ratchet wheel.	10
Various frictions and defects.	12
II Click-and-ratchet work.	13
III Fixing the winding stem.	17
IV Hand setting.	20
Hand setting with a push piece.	20
Interior hand setting.	21
Negative hand setting.	23
V Rocking-bar keyless mechanisms	25

Introduction

If one is aware of the thorough technical research which is carried out daily by modern manufacturers, and if one studies the improvements achieved in mechanical tools, one will be astonished to see some watches sold whose keyless mechanisms are so defective that they defy description.

Ignoring the articles known as trash - and yet ordinary mechanics would make it possible to obtain exactness and regularity even with the cheapest article - in many watches of average quality one finds really coarse execution and defects in construction.

Consider, for example, the winding stem. Sometimes it is not even hardened, due to being made out of iron; if it is turned it is beautiful, because often it is filed, or rather scraped, and has the appearance of a nail rather than an arbor of a horological mechanism.

The pivot at the end is too short, often resembling the body of a shoe nail with facets; and after a little use it works in a mixture of oil and brass filings similar to that which one obtains when a hole is bored.

The square of the crown is inferior in execution ... turn it to wind and the crown comes off in your hand!

The complete mechanism is a masterpiece of inaccuracy. It jumps, it scrapes, it squeaks!

Constructions of this kind are a nightmare for the repairer, but that does not prevent them from being patented, unsuitable as they are.

The most obvious proof of this fury of invention with regard to this part of the watch, is in the catalogues of the supply merchants, which give, for the few tens of parts sufficient to form a keyless mechanism, several thousands of models, from the simplest forms to the strangest combinations. And often people still complain about a lack of choice.

It is to the repairer that falls the ungrateful task of trying to put into working order these mechanisms which are often so badly designed, and it is work to which he sometimes has to devote much time without obtaining satisfactory results, because it is not easy to succeed in making function, under good conditions, a winder whose construction was miscarried.

However, by proceeding with thought and method one can obtain a satisfactory result, and the goal of the following words is to help those who have not had sufficient experience to quickly arrive at a good solution. We will not describe the hundreds of existing systems, it would be useless and take too long; we will deal only with the most common designs and that will be sufficient, since the principles are almost always the same.

I Gears.

The winder is *soft* - to employ the usual expression - when the ratchets are cut correctly, laid out suitably and are well proportioned in size. When the proportions are not right or the ratchet teeth are not cut in the correct form, one feels them scrape and winding is done by jerks; the winder is *hard*.

If the theoretical proportions were not established correctly by the manufacturer, the correction of the mechanism will be very difficult and one will rarely manage to obtain a good winding action. A complete transformation of the mechanism requires a very deep knowledge of the theory of gears and it can be done only at a relatively high cost, which the customer generally refuses to accept. Thus the watchmaker almost never has the occasion to undertake a transformation of this kind.

It will be much more useful to him to study the causes which make the gears defective and the winding hard, and to seek the simplest and fastest methods to correct the defects which are found.

That which can be got to work with a little thought will quickly produce a return, if such defective gears can be improved without too much trouble or waste of time and he can make the requisite changes to achieve that goal under the best possible conditions.

If one can immediately recognize if such repair is worth the trouble to undertake and, especially, if one can see by what way it is advisable to undertake it, to quickly make it good, one often avoids vexations and waste of time.

Gearing of the winding pinion with the crown wheel.

This gearing can be the source of many defects. To assist the understanding of the arrangement of the two mobiles, placed at right angles to each other, we will make use of figure 1, which gives an enlarged view. *T* is the winding pinion loose on the winding stem *W*.

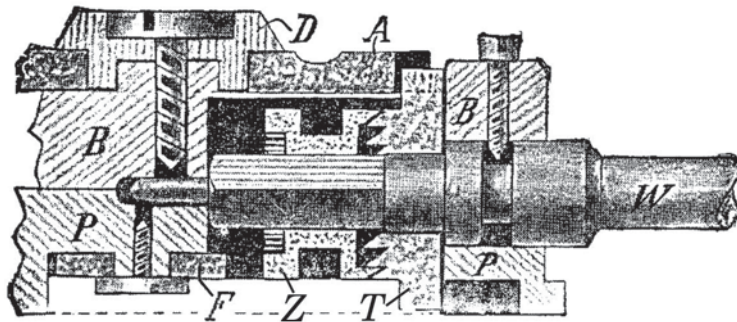

Fig. 1

The winding stem is placed between the barrel bridge *B* and the plate *P*, an arrangement which one meets in almost all watches. It is held in place either by means of a screw, as shown in the figure, or by a clamp (a small steel bridge) acting as a spring. It enters a throat in the stem. We will discuss this later, with details of the various methods of fixing the stem.

On the square of the stem is the castle wheel *Z*, which can move along this square and which, by the action of a spring, is held against the winding pinion *T*. For the function of hand setting the castle wheel is moved against the intermediate wheel *F*, and the crown teeth which it carries mesh with this intermediate wheel. This intermediate wheel turns the minute wheel, either directly or by another intermediate wheel.

The transmission wheel *A*, is mounted on the barrel bridge, where it is held under a core *D*, fixed by means of a left-hand screw, and around which it rotates. This transmission wheel is turned by the winding pinion *T*, with which it gears at a right angles.

Figure 2 shows the action of this gearing, shown from the top at *I* and from the side at *II*. In the two drawings the winding pinion is marked *B* and the transmission wheel *A*, the latter turning under the core *D*, in which the head of the left-hand screw *L* is recessed.

If, when the watch is being wound, one feels jamming or butting of the gears, and assuming the depthing is good, this comes from the bad meshing of the teeth in each other. One should not however confuse these defects with those which can come from the action of ratcheting¹ which takes place between the winding pinion and the castle wheel; we will speak of this action a little later.

¹ *décliquetage*, when the crown is turned in reverse to the direction for winding; I know what it sounds and feels like, but I cannot think of an English word to describe it!

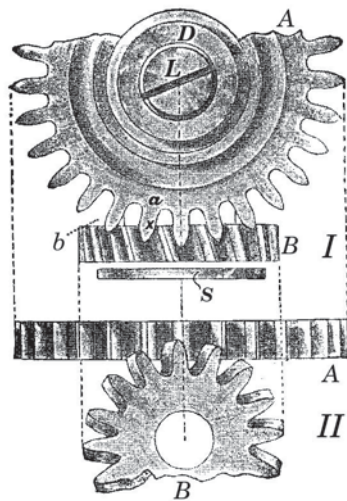

Fig. 2

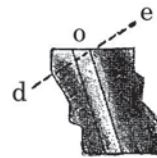

Fig. 3

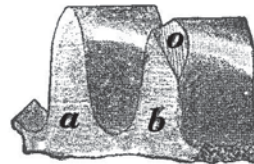

Fig. 4

Jamming in the gearing of the winding pinion with the transmission wheel can have three different causes:

1. It can occur between the edge of the slanted teeth of the winding pinion *B* (see fig. 2, view *I*) and the side of the teeth of the transmission wheel *A*, as one sees on the tooth *a* at the place marked with a cross.

If the penetration of the gears is too deep in this direction, so that the teeth of the winding pinion go almost to the bottom of the spaces between the teeth of the transmission wheel, the friction which occurs is corrected in the following way: the pinion is put on a turning arbor and the teeth cut skew with a file or graver, according to the dotted line *b*.

If the penetration of the gears is good and the bad friction is caused by the teeth of the winding pinion being too wide or their slope too steep, the edge *o* is filed skew, according to the line *de* (fig. 3). One sees in figure 4, the tooth *b* dealt with in this way, beside a tooth which is intact.

2. There can also be friction caused by the edge of the transmission wheel teeth on the ogive (the tip) of the winding pinion leaves; the view in figure 5 shows this defect; the tooth *d* of the transmission wheel is rubbing against a leaf of the winding pinion.

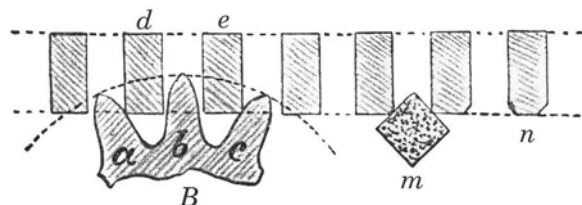

FIG. 5

In this case, one makes the defect disappear by cutting down, underneath, the edge of the teeth of the transmission wheel. For this purpose a square file is used, with which one files two teeth at the same time as shown at *m*; the result of this operation being shown at *n* (fig. 5), where one sees the form of a tooth whose angles have been relieved by this means. Figure 6 shows the teeth in perspective after they have been filed as explained.

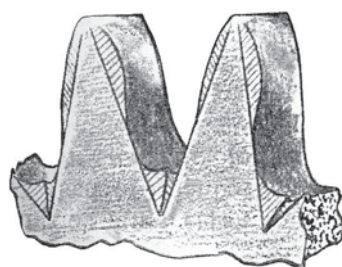

Fig. 6

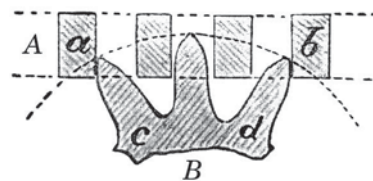

Fig. 7

If the depthing, examined in the direction shown at *I*, is obviously too shallow, and if there is not a thicker pinion at hand to replace it, the defect can be cured by placing a steel or brass disc against the back of the pinion. The depthing can be changed at will by varying the thickness of this disc, *S* (fig. 2).

If the gearing is too shallow in the direction *II* (fig. 2), there will also be jamming of the inner edges of the transmission wheel teeth against the rounding up of those of the winding pinion; then one must increase the depthing in this direction as well.

But it is necessary that the play of the teeth allows for this increase; if the play is not sufficient, which happens when the teeth of the winding pinion are too broad, bringing the gears closer together is not possible. In this case one can only alter it by skew filing the teeth of the transmission wheel.

It is different if the play of the teeth is too large; the correction will then be obtained by increasing the depthing, which can be done in two different ways. The first of these consists of replacing the winding pinion by a larger one; the second is to lower the transmission wheel.

Lowering the transmission wheel can be done only after checking that this wheel has sufficient clearance from the center wheel. One then turns, with a fixed graver², the part of the barrel bridge on which the transmission wheel rests, so that it can go lower. It is then necessary to lower the core by the same amount; otherwise the play of the wheel would nullify the operation.

The replacement of the winding pinion by a larger one is advisable when it is noted that the ratio of the sizes of the mobiles is not correct. Figure 5 shows, for example, that the teeth *d* and *e* of the wheel are tight between the teeth *a* and *c* of the pinion; it is clear that if the pinion were larger these two teeth *a* and *c* would be further apart.

But if butting of the teeth occurs although the ratio of the mobiles is correct, and there is good depth of gearing, one will succeed in improving the action by replacing the pinion by another of the same size, but with narrower teeth; the spacing of the teeth will be larger and the result will be the same as if a larger pinion were put in.

3. Butting of the teeth of the winding pinion between those of the transmission wheel is also a cause of hard gearing. Figure 7, where one sees the teeth *c* and *d* of the winding pinion taken between the teeth *a* and *b* of the wheel, shows this defect clearly, which comes from the meshing of the skinny teeth of the pinion being too deep, or their number is too small.

We have several means of correcting this. To decrease the diameter of the pinion by turning it and rounding its teeth; to replace the pinion by a smaller one; to replace it by one of the same size but having one more tooth and, consequently, the pitch of the gear will be smaller and the teeth will be closer together.

From this outline of the defects which one can meet in these first gears alone, one realizes already that the number of defects which can exist in the complete mechanism is very large. Thus one should not be astonished at meeting defective keyless mechanisms so frequently. The faults generally come from many manufacturers making the serious error of regarding and making the keyless mechanism as an accessory of the watch.

However, a watch assembled with a defective winder when it is made will not give long term satisfaction to its owner, and the watchmaker who receives it for repair is likely to have serious trouble. Frequently the customer, and especially the female customer, complains about the irregularity of the watch, without realizing that this irregularity comes from he or she not winding it up fully, because of the friction, the squeaks and the jumps of the winder.

This is why a watchmaker must be a good tradesman at the time of purchasing new watches, to always attentively examine the keyless mechanism and not to order pieces in which this mechanism appears doubtful.

We do not want to close this first section, examining the gearing of the winding pinion with the transmission wheel, without recommending in particular the mechanisms which have adopted the bevelled or angled gear for these two mobiles. This system is used in the watches of Glashütte and some quality pieces made in Switzerland

It is really a pleasure to feel the softness of keyless mechanisms equipped with such gears; and as there is, so to speak, never any need to improve them during repair, we do not have to stop and say more.

2 A cutter mounted on a slide rest.

Gearing of the winding pinion with the castle wheel.

The winding pinion and the castle wheel communicate by means of triangular or ratchet teeth, cut in opposite directions on each mobile. Action takes place by the gears meshing when turned in one direction, and there is disengagement in the other direction.

The fact that these two mobiles have to support all the force of the mainspring which operates the watch, makes it clear that they must work together with absolute safety.

The castle wheel is especially significant, since it transmits the rotation of the stem, on the one hand with the winding pinion to wind the watch, and on the other hand with the intermediate wheel for hand setting.

In keyless mechanisms of lower quality, it is common to feel abrupt jolts or jumps which occur at regular intervals or irregularly, even though all seems to be in good order in the mechanism. These jumps are the result of bad meshing of the castle wheel teeth in those of the winding pinion; one seeks in vain to increase or to ensure this meshing by strengthening the lever spring; but no improvement is obtained.

This defect often comes from the teeth of the two parts being worn; figure 8 shows us that in this case there cannot be a sufficient catch for the gearing to be done safely. Even if only one of the two sets of teeth are worn there is not the necessary certainty.

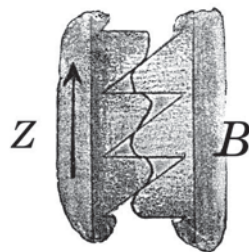

Fig. 8

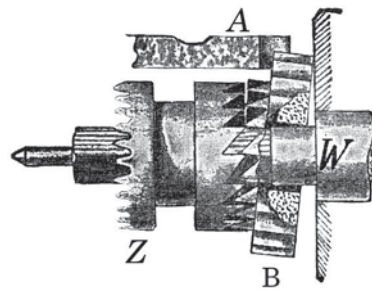

Fig. 9

The replacement of the defective pinions is absolutely essential in this case and, as wear can occur from a defect in hardening, one will take care to harden the new parts suitably and to temper them to red or to the first blue so that the teeth, while being guaranteed against wear, are not too fragile. This degree of tempering is also appropriate for the other ratchets of the keyless mechanism.

It can happen that disengagement of the teeth occurs although they do not show any wear; the defect then comes from the bad adjustment of the winding pinion on the stem. It is known that the winding pinion, supported against a shoulder, turns on a pivot on the stem, while the castle wheel rides on a square extension of this pivot, along the length of which it can slide.

If the pivot is too small or if it is not cylindrical, the winding pinion, in consequence of the resistance which it experiences in its action with the transmission wheel, sits skew. Figure 9 shows, with a little exaggeration but all the more obviously, how this occurs. *B* is the winding pinion, *Z* the castle wheel, *A* is the transmission wheel and *W* the winding stem. The winding pinion *B* is represented by a section through its hole, which makes it possible to see how the part can sit skew on its pivot in consequence of this hole being too large.

In this position, only some of the teeth of the castle wheel penetrate to the base of those of the winding pinion; the defective contact which results is not sufficient to ensure the regular control of parts which transmit relatively large forces, and unexpectedly the teeth escape. The winding pinion again takes its normal position, but not for long, and the jump or unmeshing invariably repeats at regular intervals or erratically.

If the pivot of the winding pinion is too short or too long, defects which are shown in figures 10 and 11, the gearing of the two pinions is also dubious.

The danger is especially great in cheap hunter watches, where the crown is fixed on the stem and where, consequently, the stem itself is moved inwards when operating the case spring by pressing on the crown. In this case, the throat *E*, in which the fixing screw *R* sits, must be sufficiently wide to allow the displacement of the stem (see fig. 10).

If the pivot of the winding pinion is too long, its end can reach the square hole of the castle wheel. If, while winding the watch, one presses involuntarily on the crown, the castle wheel is pushed in, moved away from the winding pinion, and the gearing of the two parts is no longer made at full depth.

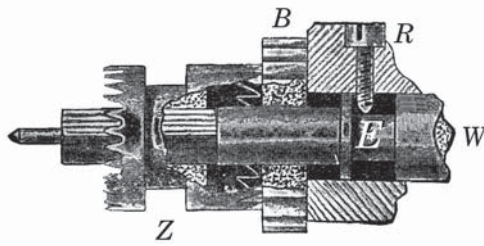

Fig. 10

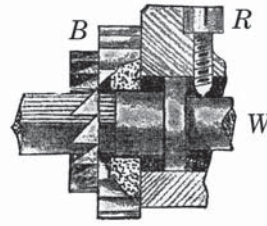

Fig. 11

If the pivot is too short, as shown in figure 11, the winding pinion is supported by only half the length of its hole and it easily sits skew, as in the case of a pivot that is too small. The result is always uncertainty of the gearing in consequence of the unequal penetration of the teeth into each other.

The push piece for hand setting can also be the cause of defective engagement of the teeth, when it prevents the free movement of the lever operating the castle wheel. We will examine this point a little later when we deal with hand setting. For the moment we continue to examine the various gearings.

Gearing of the transmission wheel with the ratchet wheel.

This gearing is rather easy to put in order because it can be observed more conveniently than those above.

It will be uncertain if the wheels are not in the same plane, or if they have too much play under the ratchet-wheel cover; one mobile can then pass over the other. Enlarged holes or worn shoulders are also causes of faulty operation.

If, for example, the hole in the barrel bridge, from which the square for the ratchet wheel emerges, is enlarged or thrown to one side by wear, the gearing loses its depth and acts with harmful friction.

In many keyless mechanisms of old construction, the transmission wheel turns on a core made of brass and not steel as is currently done. Whenever one meets these brass cores they are worn on one side so that not only the gearing of the two wheels is bad, but also that of the winding pinion and the transmission wheel.

The remedy consists in fixing a steel ring around the worn core, and figure 12 shows how to do this. One sees at *a* a core deformed by wear. It is turned using a fixed graver in order to make it circular, which can only be done by decreasing its diameter. One then makes a steel ring *c*, whose external circumference corresponds to the hole of the ratchet-wheel, while the interior circumference is adjusted to fit the prepared core. If this adjustment is done carefully, a few light blows of a hammer suffice to fix the ring firmly in place as shown at *d*. If it is not tight enough and one fears that it will turn on the ratchet-wheel, it is fixed by a hole *e*, bored through the ring and into the core, and a pin is driven into this hole.

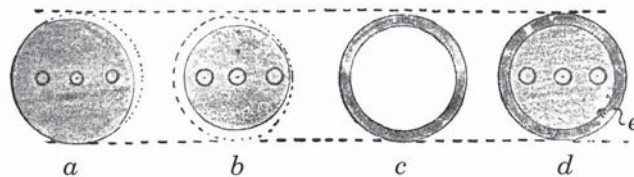

Fig 12

The hard operation of a keyless mechanism can also come from lack of freedom of the transmission and ratchet wheels.

It is necessary to firstly see if the transmission wheel is quite free, the core being tight on the base. The ratchet-wheel can also lack freedom when, as shown in figure 13, the square of the arbor, which carries the ratchet-wheel *H* does not come level with the hollow in the barrel bridge *F*. In this case, the core *D*, when screwed down, tightens the ratchet-wheel onto the bridge.

It is a question, in this case, of not making a correction likely to create another defect. This could happen if the under side of the bridge were turned to decrease the length of the hole, without first checking to see if, by raising the barrel, it is likely to rub on the center wheel.

If the ratchet-wheel can be lowered without it rubbing on the center wheel, the length of the hole can be decreased the from above; that is, to deepen the hollow in which the ratchet-wheel sits.

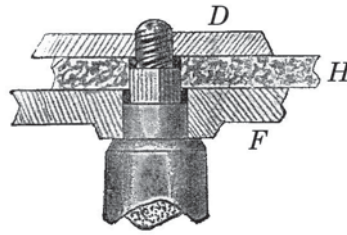

Fig. 13

If neither one nor the other of these two corrections can be adopted and it concerns a watch whose low price does not allow the replacement of the barrel arbor, one will have to be satisfied with tightening the tapped hole in the core by forging it with a round punch. By this operation, one obtains a core that can be screwed tight on the arbor and which, although it is not tight on the base, is not likely to unscrew itself.

With regard to the same gearing, it can very often be necessary to improve it. If it is obviously too shallow and if the action is hard with jolts, the only remedy is to replace the ratchet-wheel by another a little larger.

If the gearing is too deep, the action will also be hard. One will have to put in a smaller ratchet-wheel to correct this defect. However, if it is a very ordinary watch, one can reduce the ratchet-wheel by rounding it.

But the gearing can be hard even though the depthing is correct. That occurs when the diameters of the transmission and ratchet wheels are not in accord with their numbers of teeth. It is then necessary to correct this ratio by putting in a ratchet-wheel with the necessary number of teeth.

In this case, as in the previous ones, it is the ratchet-wheel which should be replaced, because if one altered the transmission wheel the operation of this wheel with the winding pinion would be modified.

Figures 14 and 15 show us two gearings of these wheels. *A* is the transmission wheel, which turns in the direction marked by the arrow and leads the ratchet-wheel *H*, which is the driven mobile.

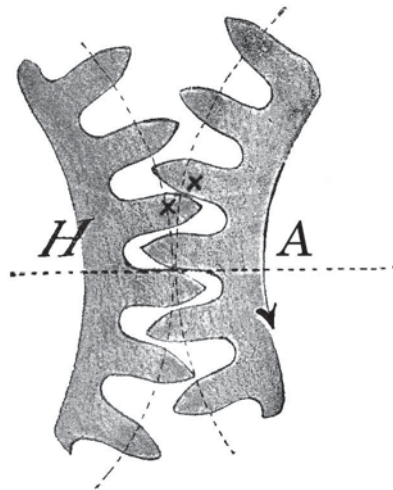

Fig. 14

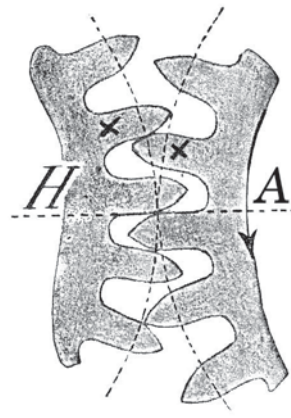

Fig. 15

When the teeth of the transmission wheel which leads, butt hard against the round-off of the teeth of the ratchet-wheel, as shown in figure 14 at the point of contact located between the two crosses, the spacing of the teeth of the ratchet-wheel is too large; that is, the number of teeth is too small compared to its size. If another ratchet-wheel is used, of the same diameter but having a larger number of teeth, 3 to 5 teeth more for example, one will be surprised by the result; the gearing will become very soft and will act without jamming.

With the thin shape of the teeth that we show in our drawings, which we believe is the most correct form, it is difficult to realize the extent which the influence of these teeth being too far apart can be bad. But one can have an idea of it by visualising wider teeth, with a short ogive, as one sees them in all ordinary watches.

If the number of teeth of the ratchet-wheel is too large (that is, if the pitch of the gearing on the ratchet-wheel is smaller than on the transmission wheel) there will be the defect which is shown in figure 15. Each tooth of the wheel which leads can only enter the spaces of the other wheel with considerable friction. In this case, the defect is corrected by replacing the wheel *H* by another with teeth further apart; that is, by a wheel having a smaller number of teeth, the diameter remaining the same.

One can see, by sitting one of the wheels on the other, if the pitches are the same. When sending to the supply merchants for a ratchet-wheel, it is advisable to include the wheel with which it must gear; a wheel will be provided which is more suitable.

The system called *wolf's teeth*, which were in fashion for a while, have fortunately been given up. We say fortunately, because the use of this shape of teeth, which should give very soft gearing, generally produced the contrary effect to that which was wanted. Moreover, it is very difficult to obtain spare parts with this kind of teeth.

Various frictions and defects.

But it is not always enough to have rectified the gearing to obtain a keyless mechanism both soft and moving easily. It is necessary to remove all unnecessary friction and, above all, to smooth the underneath of the transmission and ratchet wheels as well as possible. This smoothing can be done most easily by means of a fine emery buff-stick. We do not know why these wheels are generally left so rough underneath; it would not cost the factory any more to make them smoother, and the watchmaker would save many buff-sticks, which are immediately scratched by the strong burrs which are left there.

The winding stem must also be perfectly smooth at all its points of friction; otherwise it produces a rapid wearing. The first requirement to obtain a soft winder is to take care that the stem is quite free when installed with its screw or clamp tightened. Lack of freedom in this part can be caused by:

A screw which is too long; or a clamp too broad, entering the throat of the stem with difficulty.

The screw of the transmission wheel core is too long, reaching the pivot on the end of the stem.

The castle wheel is too large, rubbing under the transmission wheel.

The winding pinion lacks freedom on its pivot.

The pendant is badly soldered so that the stem rubs inside it.

The pivots of the ring are too long and rub on the core of the transmission wheel.

The movement is badly fitted in its case and is able to move, especially when it lacks steady pins to ensure its position. In the latter case, it is the winding stem which prevents the plate turning and sometimes it is treated as if this were its only *raison d'être*.

Under these circumstances, one should not be astonished that we meet defective winders so often!

Let us say finally, that when one is in the presence of a watch whose winding crown is so worn that it almost resembles a ball with a smooth surface, one will do well to suggest to the customer that this part be replaced. Because the fingers should not slip on the crown, so that one feels the action exerted while winding.

II Click-and-ratchet work.

There is no mechanism simpler than click-and-ratchet work: a click penetrating into the teeth of a ratchet and a spring pressing against this click. The shape of these two parts is indicated by their very function. So one wonders what is the goal of inventors who, by creating all these new shapes of clicks and springs which, under pretext of improvement, are continually being introduced into manufacture.

What good are all these innovations and so-called improvements which, in the majority of cases, are made only at the expense of solidity? Wouldn't one do just as well by simply using what already exists, which is recognized as good, instead of insisting on making something new?

The researchers and innovators seem to attack the click-and-ratchet work in preference; they undoubtedly find that it is easier to modify this mechanism than to bring changes to the train or the escapement!

As an example of what this mania to make something new leads to, we will give the following beautiful result:

Under a click in the shape of disc, is dissimulated a fine spring in an arc of circle, whose ends, bent at a right angle, enter, one in a hole in the click, and the other in a hole in the barrel bridge. With these simple facts, what a splendid statement one can make for a patent application!

But, in practice, what happens? One of these click-and-ratchet works ceases functioning, because one of the ends of the spring has left its hole. The watchmaker starts, quite naturally, by removing the screw which retains the disc-click in order to see what there is underneath. He finds nothing there at all, but a small tingling at the end of his nose tells him that there was something, and that this thing jumped up to hit him in the face and then lost itself far away!

Where is this part now and what shape did it have? The watchmaker, who has never seen this system before and to whom this mishap is certain to happen, curses the inventor and the manufacturer!

In our description of the various designs of click-and-ratchet work both good and bad, it goes without saying that we will occupy ourselves with those most commonly used. The principle of operation is, all things considered, always the same and it is not necessary to study those systems which had only a transitory existence. One would need a book to describe all the kinds of click-and-ratchet work which have been imagined and, in such a book, a significant chapter could be devoted to the systems which were never more than valueless curiosities.

The characteristics of good click-and-ratchet work, the points which, above all, must attract the attention of the watchmaker, are as follows:

The click, whatever its form, must mesh correctly and with safety into the teeth of the ratchet.

The pressure of the spring against the click must be sufficiently strong without being too hard, and that this pressure takes place on the back of the click, above or below.

The spring and click can be made as one piece, provided its action has the desired result.

To start with one of the simplest systems, let us mention that which one very often meets in cheap watches and which is generally used with the mechanisms called *rocking-bar* winders, which are laid out under the dial. We will return to this kind of keyless mechanism at the end of our study.

We see in *A*, figure 16, a correctly built click-and-ratchet work, while that which is represented in *B* has the often met defect of having a spring which is too long. The click and spring are made as a single piece; *r* is the ratchet mounted on the barrel arbor and which is seen through the opening in the plate.

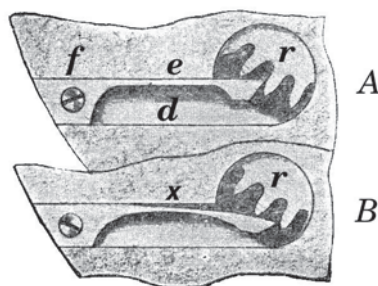

Fig. 16

When, as seen in *A*, the blade *d* of the spring rests against the wall of the hollow at *e*, and is rather long so that the end of the click penetrates well into the teeth of the ratchet, one has a click-and-

ratchet work which gives satisfaction. Of course, the blade d should not be too weak, because then it would bend under the action of the mainspring tending to move the ratchet back; this bending would cause it to break sooner or later.

The foot f must be adjusted without any play in the space allowed for it; if this were not the case, the movement which the part could make would tend to loosen the screw.

A significant point is the degree of tempering of the click spring after hardening; the part working in the teeth of the ratchet should not be tempered further than yellow, while the spring will have to be heated to a light blue. A click tempered too much will wear quickly, because it is necessary that the spring presses on it rather strongly.

The insecurity which the click-and-ratchet work in B presents, jumps out at the eyes when compared with A . First, the part of the spring which bends is too short; bending hardly occurs until the point marked by a cross. Moreover, the spring cannot rest against the plate, so that nothing supports the click to help it withstand the force of the mainspring. The risk of the click spring breaking is very great, especially if it is left a little too hard.

One can correct the defect by shortening the click and increasing the length of the blade of the spring by appropriate filing.

Figure 17 shows a sophisticated design of the click-and-ratchet work which we have just described, and which one meets quite often. This system, mounted on the side of the barrel bridge, comprises a click and a separate spring. The click S , the foot of which is placed in a notch made in the bridge, swivels on the pin d , also shown in the recess in the bridge K . The body of this click, sufficiently raised to be at the height of the ratchet, rests against the side of the bridge. The spring, a simple blade notched for the passage of the barrel, is held by the screw r .

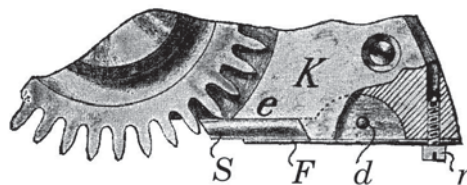

Fig 17

The recommendations made about the system previously described also apply here. The click should not be too long, because it would not return to rest against the bridge. It should not have too much play in its notch, otherwise it would be likely to sit skew and to jump.

Figure 18 represents one of the click-and-ratchet works most frequently used. The drawing shows this mechanism afflicted by three defects. First, the click is too long; the spring is, on the other hand, too short; moreover, it is prevented from reaching the click by the edge e of the bridge.

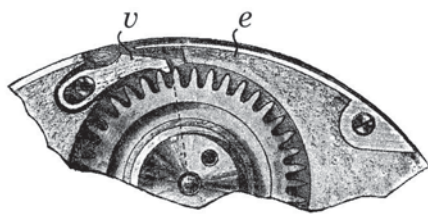

Fig. 18

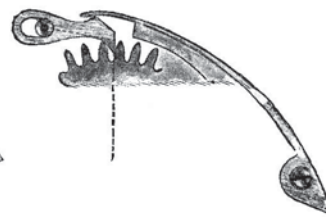

Fig. 19

We have, in the drawing, removed the screw of the click to show the elongated shape of the hole in this part. This serves two purposes. As the teeth of the wheel in which the click works do not have the usual shape of the teeth of click-and-ratchet work, but the epicycloidal shape of ordinary gear wheels, it can happen that the point of the click, when the watch is completely wound, does not fall down to the bottom of a tooth, but stops against the ogive. Then the ratchet will be able to escape and the click will break if it is not very solid.

In addition, at the moment when the watch is fully wound, there is an abnormal tension on the mainspring which can cause banking of the escapement and consequently disturb the rate of the watch.

It is to avoid these two disadvantages that the hole in the click is elongated. However, if the spring is too short, so that its end can only reach face v of the click, it prevents the click from advancing in the direction of the rotation of the ratchet during winding, and the lengthening of the hole has no effect.

The end of the spring must, as shown in figure 19, rest, either on the point of the click, or in the part hollowed out between the point and the hole. It is necessary that the click can easily move forward and backward; for this purpose, if the point is too sharp it is rounded a little by smoothing it, and one also smoothes the part of the spring blade which rests against it.

A click which is too long cannot work with certainty in the teeth of the ratchet. Let us form at the point of contact of the tip of the click and the tooth, an angle whose sides end, one in the center of the ratchet and the other at the point of swivelling of the click; if this angle is acute, less than 90° , the click is too long. In click-and-ratchet work with triangular teeth, it is recommended that this angle has an opening of 90 degrees, to place the point of swivelling of the click on the tangent. When the ratchet has epicycloidal teeth it is preferable to have the click a little shorter.

One will realize the appropriateness of this by examining the click-and-ratchet work shown in figure 19. It is seen here that the angle is obtuse, and we immediately see that this mechanism cannot fail to fulfil its goal; that is, it is of solid and certain construction.

Almost all of the recently invented click-and-ratchet works are laid out so as to allow an amount of recoil of the ratchet when the watch is fully wound. This design is adopted especially to remove the danger of stoppage, by providing the means of avoiding the excessive tension of a fully wound mainspring. The systems which answer this condition are already very numerous and they present several defects.

Figure 20 represents a very simple click-and-ratchet work of this kind, and shows how the effect of recoil is obtained. The click swivels on the core a and, in its normal position, rests against the wall e of the notch made for it. During winding, its point traverses an arc which extends to C , to its exit from the circumference of the ratchet teeth.

Thus the ratchet moves back by the corresponding amount once winding is complete, until the click is again supported against the wall e .

The resting face of the click stops on the straight line joining the point of pivoting to the center of the ratchet, and it is at this moment that the meshing with the teeth is deepest. There is thus all the safety necessary. The spring f pushes the click back in the direction of its resting position after the passage of each tooth. In this design the angle of recoil, as shown on the drawing, is 15 degrees.

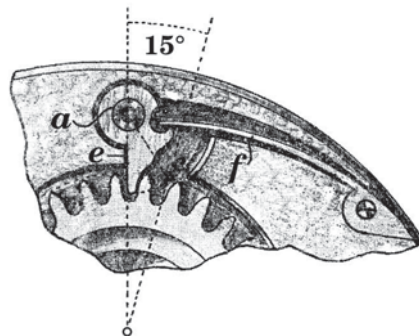

Fig 20

Click-and-ratchet work of this type has been built in which the angle of recoil is double and even three times that noted above. This result is obtained by using clicks with several teeth, which makes it possible to move back the wall against which it rests.

The safety of click-and-ratchet work also depends very much on the way in which the click is held in place. It is usually held by a screw with broad head, but if it has too much play under this screw it can easily pass over or under the ratchet; the play is decreased by reducing the height of the core to lower the screw a little more.

The click can also be too thick; or rather, the core for the screw can be too low because a thick click is never harmful. In this case, when the screw is tightened to the bottom it does not allow any movement of the click. This defect absolutely must be corrected with the aim of providing the desired freedom, because it is quite out of the question not to tighten the screw completely.

If the click has a round hole, this hole is countersunk down to the core. Then one files a circular facet, corresponding to the countersink under the head of the screw (see fig. 21). The screw can then be screwed down and tightened while leaving the click with the necessary freedom.

If the click has an oval hole, we will thin the piece around the hole, leaving its full thickness at the point.

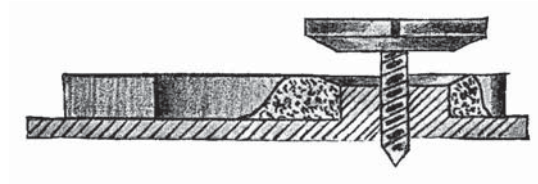

Fig. 21

It sometimes happens that the spring escapes from its support against the back of the click and goes up over it. That often occurs when the pieces are thin and their faces of contact are not square. This problem can be removed by curving the blade of the spring slightly, so that its end tends to rub on the bridge. But then it is necessary to carefully round and smooth the lower part of this end, so that it does not scrape, as is sometimes seen in ordinary watches where the spring, by its friction, has dug a veritable furrow.

III Fixing the winding stem.

The watchmaker who does a repair risks getting a bad reputation, if the customer is obliged to bring back the watch after few days, because crown with its stem is lost, or at least has come out. In the majority of cases, the workman is caught by this accident only because he generally gives little attention to the fixing of the stem.

Whatever the system adopted for fixing, it is necessary that the screw which holds the stem or which fixes the clamp is tight. This is an essential condition to obtain, at the same time as having the necessary freedom and a durable solidity; because a screw not completely tight will certainly come loose sooner or later.

The manner of fixing the winding stem has also undergone many modifications; and the changes which were brought to the simple methods generally adopted were very often unhappy experiments rather than improvements.

The usually method of fixing the stem is either by a simple screw or by means of a clamp.

The system most generally employed, the simplest and therefore the most economic, consists of a screw which goes through the barrel bridge and whose end enters a throat in the winding stem. The simplicity of this method means it is used in cheap watches, but its execution is sometimes negligent.

It should also be said that the screw in question, of small diameter, has to withstand relatively large forces. It is charged with retaining the stem at the end of which the crown is fixed; the latter is outside the case and is exposed, even in the pocket of the watch carrier, to shocks and continual tuggings. Not to mention the forces which it withstands every day when the watch is wound up or the hands set.

Moreover, how often does one see people having fun, simply because of idleness, turning this crown unnecessarily, just for the pleasure of listening to the ratcheting. If these people realized that the stem that they are turning is retained only by the point of a tiny screw, they would understand that this recreation should be avoided.

Also, when this screw is not hardened its point wears and penetrates only half way into the throat of the stem, and if the throat is not turned cylindrical one can see how much more easily the stem can escape.

If care is taken to put in a suitably hardened screw which, once tightened, enters definitely into a sufficiently wide and deep throat in the stem, and whose head is high enough to touch the closed case cover, one will never have to fear the loss of the stem.

The simplest way to correct a defective throat is by turning it, after having put it in the lathe by means of an American chuck, or by filing it with a square file in a screw-head tool.

Obviously it can happen that the stem becomes too weak at the throat, but the customer will only blame himself if he breaks it, while if he drops and loses it he will always accuse the watchmaker having badly fixed it.

It sometimes happens, when the screw which holds the stem is placed near the edge of the barrel bridge, that its hole bursts. Under these conditions it is no longer possible to make the screw grip.

The simplest way to cure this problem is to put in a new screw, not in the bridge but in the plate on the dial side. That will necessitate removing the dial to take out the stem, but that way it can be firmly fixed again. But for one reason or another, it can happen that this method cannot be used; here is another way, which is very practical and also very simple.

One drills two holes in the barrel bridge which also go into the plate, as shown in figure 22; into these two holes one introduces, from the top of the bridge, a steel wire *e* formed like a staple, whose two branches enclose the stem by passing through its throat. An attachment thus repaired is very certain and very durable.

However, if it is a well-finished watch it is preferable to proceed differently. One makes a small steel bar *b*, figure 22, in the middle of which a tempered steel pin *S* is firmly riveted. This bar is attached to the barrel bridge by means of two screws, so that pin enters the old screw hole and goes into the throat.

It should be noted that in well-finished watches the stem is generally fixed by means of a spring clamp, a system which gives better results than a simple screw.

When this clamp is used in ordinary watches it often leaves a lot to be desired. A most defective arrangement, that one often meets in ladies' watches, is shown in figure 23. The defect consists especially of the fact that the clamp is too weak; it leaves the throat easily if it does not enter it sufficiently. It is thus necessary to check it carefully, after having removed the barrel bridge.

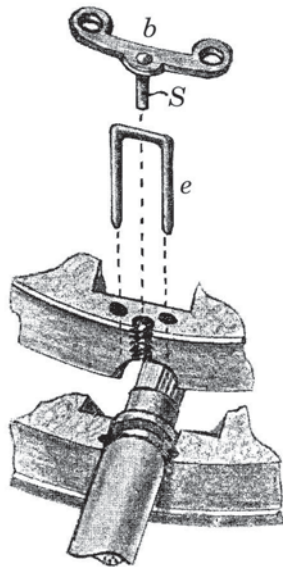

Fig. 22

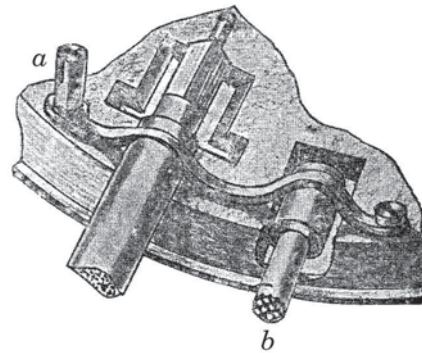

Fig. 23

Above all, care should be taken that the long head of the fixing screw *a*, is quite free in the hole in the bridge for it; if it rubs on one side or other of this hole, one cannot feel, when turning it, the force that one is exerting on the clamp.

A clamp thus laid out presents yet another disadvantage in consequence of it passing over the push piece for hand setting. Although it is bent in order to circumvent this push piece, it can happen that, once tightened, it prevents the push piece from returning after using it to move the hands.

To find this irregularity in operation of push piece, one must start by taking the movement out of the case; but, at the moment when the support is loosened the push piece comes out. One is thus not likely to see at a first glance how the defect is produced.

The support being generally thin, it is rather easily curved to give the desired space at the push piece, but it is advisable to be sure of the degree of hardening if one does not want to risk an annoying accident. Often the most practical way is to decrease the diameter of the push piece, by turning or filing it.

Obviously one can manage to correct the defects which this system presents, but nonetheless it is true that they cause trouble and a waste of time, without which one would do better from a repair often poorly paid. One sees, by the example that we have just given, that one can expect all kinds of problems with badly made clamps.

The system which is represented in figure 24 is more solid and surer than the previous, because the clamp is stronger and it can yield only with difficulty. Care should also be taken that it enters easily and definitely into the throat of the stem. If, when the screw is tightened, the clamp does not reach the bottom of the throat, it should be filed underneath at *c*, having care to make it sit well on the plate.

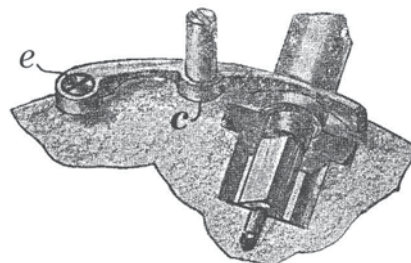

Fig. 24

What we said about the freedom of the head screwed tight in the hole in the bridge, also applies here. In both of the systems it is necessary that the clamp clearly rises when the screw is loosened; if not, the stem cannot be removed. The first requirement to obtain a correct operation of the clamp is that the screw *e* is always screwed tight to the bottom.

The solid fixing of the stem must be ensured especially in pieces with negative hand setting; that is, where the crown must be drawn out to set the hands. As it often happens that the owner of the watch pulls more strongly than is necessary to engage the castle wheel with the minute wheel, it is understood that it is necessary to ensure there is a particularly solid fitting. The lever which goes into the throat of the stem must engage it in an absolutely definite way, and the screw which holds this lever must likewise have great solidity.

In some kinds of watches the stem is made in two parts; the part which carries the winding crown is bored at its other end with a square hole in which the stem proper goes. This part, made like a key, is generally held by a screw in the case pendant and its end goes in a throat made in the core of the crown.

With this arrangement it is rare that the crown falls off, because one can make a sufficiently deep throat in the core to have all desired safety. However, care should be taken that the screw holds firmly in its hole, in the thickness of the pendant, where there are only a few threads. For the rest, if this screw comes loose there is a chance that the carrier of the watch realizes it in time, by feeling the roughness which has suddenly appeared.

All things considered, whatever the system of fixing adopted, there will always be the possibility for a reasonably skilful workman to ensure all the solidity necessary. If care is taken to make sure that the stem can turn freely with the fixing screw being tight to the bottom, one can be certain that it will not come out from its place.

IV Hand setting.

There are hundreds of designs for a function which has only one goal; thousands of forms and sizes for parts whose action is well defined. This is the result of all that has been thought of with regard to the keyless mechanism in the pendant. In this inventory, hand setting occupies a dominant place.

In the presence of the great number of designs which exist, we must give up the idea of describing all of them. We will deal only with the most current and the defects that one generally meets; it will be seen that these defects are, ultimately, almost always of a similar nature.

In pendant wound watches, the hands can be operated by turning the crown once the castle wheel is put into gear with the minute wheel.

This action can be achieved by three different methods:

1. By pressing on a push piece whose end extends outside the body of the case (hand setting with a push piece);
2. By moving a lever placed at the edge of the glass bezel. (interior hand setting, used in hunter case watches);
3. By drawing out the crown. (negative hand setting).

Hand setting with a push piece.

In hand setting with a push piece, of which figure 25 represents one of the designs most generally adopted, one can meet the following defects:

The teeth of the castle wheel penetrate too deeply or too shallowly into those of the intermediate wheel; the lever does not correctly enter the throat of the castle wheel; the lever does not return to its home position when the push piece is released.

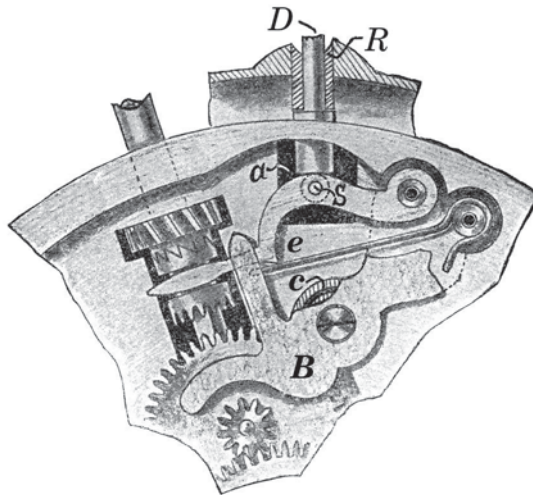

Fig 25

If the lever cannot move far enough, the teeth of the castle wheel escape from those of the intermediate wheel when one sets the hands. This defect can be caused by the following:

The lever is too tight in the throat of the castle wheel and its freedom suffers; however, if it is given the form shown in figure 25, which is the correct shape, it will function freely even if it does not have any play in the throat. The corner *e* of the lever can have a burr which causes friction, either on the plate or under the bridge *B*, whose arm prevents the lever from rising up. The spring itself can be tight under this bridge. The tube, *α* of the push piece *D* can be too long, not allowing the stud *S* on the lever to move far enough. Finally, the push piece can be too short or have side play in its canon *R*, and then it does not rest correctly against the stud *S*.

The lever cannot return to its home position when the push piece slips beside the stud *S* and is caught between it and the wall of the tube *α*. Thus it is necessary that the push piece is of a sufficient diameter and does not have a too large play in its tube. These defects, if they occur, are easily cured by putting in a larger push piece.

If push piece is too long the lever cannot move back enough, and the triangular teeth of the castle wheel do not penetrate to the bottom of those on the winding pinion.

We have already said that the lever will not return fully if it is not free under the bridge which is used to retain it. If, on the other hand, it has too much play, it can rise up, especially when there is strong resistance in the adjustment of the taper pin³. This unnecessarily too great friction makes the lever leave the throat and go up on the castle wheel; under these conditions it cannot return. This defect will especially arise if the castle wheel is a little small in diameter; it can be cured to a certain extent by curving the arm of the rocker to make it penetrate more deeply into the throat. If one replaces the castle wheel by a larger one, it will be necessary to check that it does not rub against the transmission wheel; its freedom would suffer.

When the lever advances too far, the teeth of the castle wheel penetrate too deeply into those of the intermediate wheel; the gearing, not having any drop, becomes rough. Or the ends of the castle wheel teeth even scrape against the bottom of the opening; resulting not only in friction, but fast wearing which produces fine filings that spread throughout the movement.

To prevent this excessive penetration, one bores a hole at a suitable place on the plate, in which one plants a pin against which the lever will come to a stop at the point when the penetration into the intermediate wheel is sufficient.

The intermediate wheel should not have excessive play under its screw or its bridge; otherwise it will rise up when one sets the hands and the gears will no longer mesh.

A burr is almost always formed on the teeth of the wheel which is driven by the castle wheel, when this wheel is the intermediate wheel or minute wheel itself. It is necessary to take care to remove this burr; otherwise the wheel, which is almost always made of steel, acts on the plate like a cutter every time that one sets the hands. The circular marks that one often sees on the edge of the barrel lid clearly show the effect that this burr produces on the parts with which it comes into contact. This burr can also cause friction under the bridge of the intermediate wheel and it is likely to butt on the teeth of the hour wheel if the space between the two mobiles is small; stoppage is then certain.

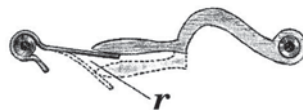

Fig 26

Very often the spring is fixed opposite to the pivot point of the lever, as shown in figure 26. If the lever is unnecessarily long it causes a very strong bend of the spring, which can easily break as a result.

If the blade is left too thick, it will not allow the lever to move to the bottom, and the mesh of the gears will be insufficient. An effective correction is carried out by shortening the end of the lever according to the dotted line *r*; the bending of the spring will be decreased almost by half.

When the lever and the spring are made as one part, as in many movements of old construction, the blade which bends should be neither too thick nor hardened too hard. In both cases one risks a breakage. On the other hand, if the spring is too thin or too soft, a false bending can occur, likely to make the gearing dubious.

Making a lever spring is an excellent exercise for an apprentice, but the expert will always prefer to get a completely finished piece from the supply merchants.

It is increasingly easy to replace a simple spring; one can thus be pleased to note that spring-levers are used less and less.

We must repeat once again that hand setting can function correctly only if the taper pin is suitably adjusted. If the resistance which this part offers is too great, it is likely, when hand setting, that the force and binding of the gearing makes the lever spring and even the teeth of the ratchet jump.

Interior hand setting.

In hunter watches the push piece system is seldom used for hand setting; the coupling of the castle wheel with the minute wheel is obtained by moving a setting arm whose end protrudes at the edge of the bezel.

³ *chevillot*. The taper pin or set hands arbor is the slightly tapered steel arbor that turns friction tight inside the center pinion and carries the minute hand. It is also common in Swiss key-wound watches when it carries a square so that the watch can be wound and set from the back.

In the system with a push piece, one is obliged to hold it in for the whole time that one is setting the hands. On the other hand, it is not necessary to hold the lever in the second system; it stays in place once the coupling is made, and one must push it back when hand setting is completed. If one forgets, the lever is pushed back automatically by the edge of the hunter lid when it is closed again.

The observations which we have made previously can also apply to this system. But another particular defect can arise; it is the lever falling down by itself when one is setting the hands.

We will use figure 27 to show this defect and how it can be corrected. This figure represents the lever with the setting arm or bolt for hand setting. In *A*, these parts are in the position for hand setting, and at *B* in the position for winding.

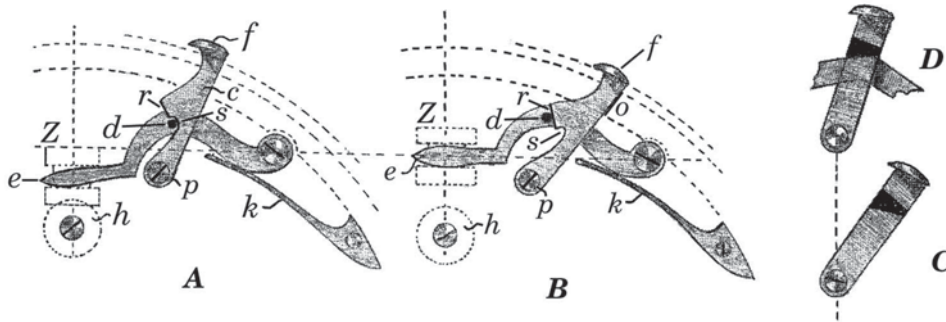

Fig 27

When the end *f* of the setting arm is pushed to the left, which moves it from the at-rest state against the bezel, the sloping face *r* acts on the pin *d* carried by the lever. When the lever is moved far enough the pin *d* will lodge in the small semicircular notch *s* and remain there.

In this position, the castle wheel *Z* gears with the intermediate wheel *h*; these parts, represented by dotted lines in the drawing, must function with a suitable meshing.

If the depthing is not sufficient, the arm *e* of the lever, which enters in the throat of the castle wheel, is bent a little in the direction of the intermediate wheel. If the gearing is too deep, one can hollow out the small notch *s* (for pin *d*) a little more. But it is necessary to take care not to file too much away and to remember that a little will produce a large effect.

For the rest, if one wants to make the smallest modification to the parts of this hand setting, it should be done only with care and prudence; otherwise one is likely to disturb the operation of the mechanism instead of improving it. The correction of a defect can very easily result in the creation of another defect.

For example, after the return of the setting arm *c* to its home position (*B*, fig. 27), the gearing of the castle wheel with the winding pinion can be too weak and consequently, not very certain; this comes from the lever being unable to move back sufficiently, because it is prevented by the pin *d* resting against the face *r*. But one should not file either the pin or the setting arm without first examining what is stopping the lever, because it may be caused by the nose *f* or the side of the recess *o* (fig. 27 *B*) in the plate or the case; correcting this will fix the defect by making it possible for the lever to move back a little further and the castle wheel will mesh deeper into the winding pinion.

As another example: the pin *d* comes out of its notch *s* while the hands are being set. In this case the lever, under the action of the spring *k*, returns to its rest position inappropriately.

If one adopts the first method of correction which comes to mind, and which consists in deepening the notch so that the pin can be retained there more securely, one will weaken the gearing with the intermediate wheel. To correct the defect which has thus been created, it will be necessary to curve the arm of the lever towards the intermediate wheel. That can, however, be avoided by forging the pin *d* to widen it; one will then sometimes have to file the notch *s* a little to give the pin an absolutely sure support.

To forge around the notch *s*, to give good depthing to the gearing or safety to the locking of the pin, is not advisable for two reasons: first, because the part is generally very hard, and secondly because it is rather thin and forging will only thin it more without producing the desired effect.

The arrangement is not the same in all watches, far from it. In some mechanisms the pin is replaced by an inclined nose, as shown in black at *C*, figure 27. This nose rests against the back of the lever, which has a triangular shape, and passes over the top, as shown at *D*, when the setting arm is moved forwards.

One quite often meets, especially in mechanisms known as *rocking bars*, another design for the setting arm. This lever is bent and, to mesh with the minute wheel, instead of pushing it to one side as in the preceding examples, it is drawn out. The general operation is, however, always the same and the above remarks also apply in this case.

The hand setting lever is almost always held by a screw with a shoulder, under which it swivels. Regarding this screw, we could repeat what we said concerning the screw for the click, but we will note only the main point; it is that a screw with a shoulder must be fully tightened. If one loosens it in order to give play to the piece which it holds, it will unscrew sooner or later.

When the setting arm rubs on the lever in such way that it obstructs the freedom of the latter, the defect is corrected by thinning one or other of the parts a little, choosing that which will support this thinning best.

Negative hand setting.

The system of hand setting that acts by drawing out the crown is called *negative hand setting* and is the most recent. The public likes this system well enough, but watch sellers like it even more; sometimes without even knowing its construction, they put forward arguments on the simplicity of its operation, which the customer is willing enough to listen to with interest.

“See! you just have to draw out the crown and then turn it to put your watch to the right time! Once it is set, you simply push back the crown in place! You don’t need to push with your finger nail to be able to carry out this operation! You don’t need to take off your gloves! This new system has only benefits!”

It could really be so, if one had been satisfied to adopt a simple system, solid and rational. But each manufacturer wants to have his own system, and there has resulted a crowd of variations and combinations each more complicated than the last, and the poor watch repairer ends up being completely confused.

Figure 28 shows a system of negative hand setting placed under the dial and whose simplicity lends itself very well to the depiction of its action.

The setting arm d is mobile around the screw S , whose head is in the barrel bridge; the end k enters a throat made in the winding stem W and the other end rests against the lever.

If the crown is pulled out in the direction marked by the arrow, arm a pushes the lever down and its end enters the notch r ; in consequence of the locking which occurs, the two parts are held in this position until the crown is pressed in.

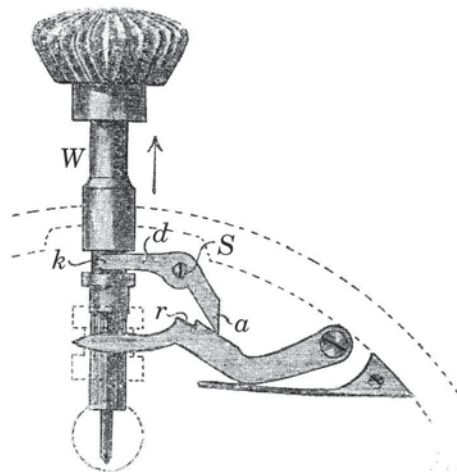

Fig 28

When the nose has entered the notch r , the castle wheel must have advanced in order to gear correctly with the intermediate wheel. Pressure on the crown then causes the pieces to return to the position shown in figure 28.

To repair a mechanism of this kind, we recommend taking into account the remarks that we made in the previous section, when discussing hunter watches.

When one examines figure 28 and one notes the simplicity with which it is possible to make a hand setting mechanism, simplicity which does not exclude solidity, it is impossible to understand why one sees the changes and complications which are emerging all the time.

But even the simplest construction can easily be defective, when it is adapted to a lady's or an extra flat watch; figure 29, which shows one of these mechanisms, enables us to realize why.

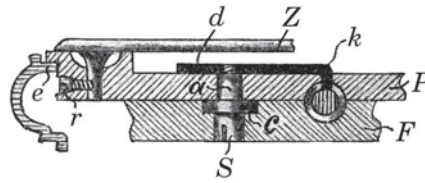

Fig 29

The lever d , whose end k enters the throat of the stem, is held by the screw S . The shoulder of this screw passes through the plate P ; the head is placed in the thickness of the barrel bridge F , and it comes flush with the top of this bridge.

If the lever d is very thin, the screw has only two or three threads. As this screw must be very tight, since it takes part in the movements of the lever and it must hold the stem, there is a great risk of it coming loose, more especially because often it is smaller than necessary.

When the lever is thick, thicker than is necessary, there is a risk, in flat watches, of it rubbing on the dial. If one wants to release the winding stem, the screw S is loosened, but the lever sits against the underneath of the dial Z before it can leave the throat, and the stem cannot be removed. Naturally, one loosens the screw still more; but as its shoulder is immobilized under the barrel bridge, the lever is obliged to rise and it will press on the dial making it bend. The tapped stem being very short, it leaves the lever completely, and the lever falls off.

But, you will say, all that can be avoided if one starts by removing the dial! Undoubtedly, but the dial is firmly fixed by means of screws at the edge of the plate, as shown in figure 29. To reach these screws, it is necessary to start by taking the movement out of the case; that is, by removing the stem! We are in the situation of the carpenter who glues a double bass and then realizes, having finished the repair, that he forgot that his pot of adhesive is still inside the instrument!

Another small disadvantage which occurs with the system of fixing the dial through the edge of the plate, is that if the screw r comes loose, its head butts against the edge e of the case band and stops the plate coming out of the case. One is obliged to force the movement out, unless one succeeds in turning it to bring the screw in question opposite the pendant hole. In this case, by inserting a screwdriver in this hole, one will manage to remove the unfortunate screw.

In short, the experiment shows that negative hand setting, despite being very tempting, can offer many difficulties, without even speaking about those caused by bad construction. One is often obliged to pull very hard on the crown to activate it; the brusque man without fear ends up by tearing it off, and the apprehensive one has great difficulty setting his watch to the correct time.

This system should not be employed in ladies' watches, nor in extra thin watches; unless of extremely good manufacture.

V Rocking-bar keyless mechanisms

The keyless system called the rocking-bar is rarely used except in cheap watches; it is almost never met in quality pieces.

Its construction, simple and economic, is well suited to the cheap watch; it offers the advantage of removing a rather significant labour on the barrel bridge, all the mechanism being placed under the dial, as shown in figure 30.

Like any other system, this one can be very good if it is well built; and very bad to the point of not functioning at all if it is badly made.

The results of bad construction do not take long to appear; just as soon as the watch is a little worn. Without speaking about the certainty of operation, we will note that teeth break off when the ratchets are too thin and too hard; the teeth wear when hardening is not sufficient; the cores on which the ratchets turn become oval; the corners of the square on the stem are rounded, etc.

Similar well made mechanisms plague the repairer, but the workman who reads all our remarks attentively, from the beginning, will be able to see what he has to do in all cases.

One can meet several special defects in rocking-bar mechanisms. One of them is the gearing of the intermediate wheel *b* with the ratchet *r* mounted on the barrel arbor and which is used as the ratchet of the click-and-ratchet work (see fig. 30). This intermediate wheel *b* is carried by the rocker *W*, mobile under the screw *c* or around a core *e* fixed by this screw. When the watch is wound, when the ratchets turn as the arrow indicates, the intermediate wheel *b* is pushed by the central ratchet *d* against the ratchet *r*.

If the core *a*, around which the intermediate wheel *b* turns, is little or not hardened, it wears on one side, and the gearing of *d* with *b* becomes weaker while the gearing of *b* with *r* is reinforced, to the point that it will no longer turn. The remedy for this defect is to make a new perfectly round core of a suitable diameter.

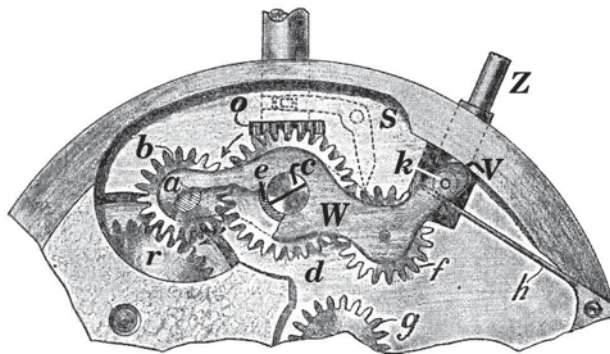

Fig 30

Moreover, it is not correct to let the teeth of the intermediate wheel *b* completely penetrate to the bottom of those of the ratchet *r*; the gearing must have the necessary play, and for that it is necessary that the depthing is regulated by a stop on the rocker. Generally the rocker is stopped by its end *v* against the edge of the plate. If there is no stud to stop it, it is necessary to put one in; for example a screw at a suitable place against which the rocker will butt.

When one turns the crown in the contrary direction, the ratchet *r*, being immobilized by the click-and-ratchet work, the teeth of *b* slip over those of *r* and there occurs, under the influence of the spring *h*, an action of ratcheting.

To set the hands, the intermediate wheel *f* must gear with the minute wheel *g*. The engagement of these two ratchets is obtained by means of the push piece *Z* which rests against the stud *k* fixed at end *v* of the rocker. The system of negative hand setting can also be used in this case; a setting arm *S*, that is represented by a dotted line our drawing, moves the rocker when the crown is drawn out. Suitably formed, the rocker returns to its rest position only when the crown is pushed back.

What we said of hand setting in general also applies to this system of keyless work.

In addition, the screw *c*, which retains the rocker and the intermediate wheels which depend on it, must be able to be tightened without the freedom of the piece suffering. It is necessary to avoid too much play of the rocker under this screw, because the intermediate wheels could disengage easily,

especially the intermediate wheel b which is, so to speak, suspended in the space reserved for the barrel and only half of its surface rests on the plate.

Sometimes one meets rockers made out of brass; there are none more defective, because wear is rapid. It is better not to take on the repair unless replacing the part by another made of steel; however, only if the watch is worth the trouble.

The ratchets must be hardened, tempered blue and well smoothed on both sides; any burr is to be carefully removed.

The depthing of the gearing of the winding pinion o with the ratchet d is done by following the instructions which we gave in the section on gearing; we will not repeat it here.
